

1	2	3	4	5	6	7	8	9	10	11	12	13	14	15
---	---	---	---	---	---	---	---	---	----	----	----	----	----	----

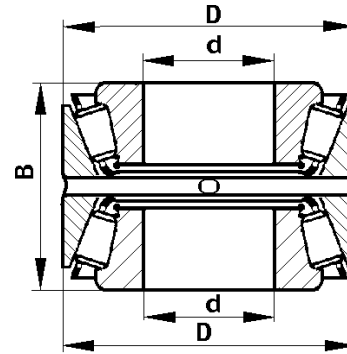

3741-2402025

57707AY

2402  
23021  
11  
11  
11  
11  
11  
11  
11  
11  
1

35

80

57

Роликовый радиально-упорный  
двухрядный с двумя внутренними  
кольцами  
Double-row radial-thrust roller bearing  
with two inner races

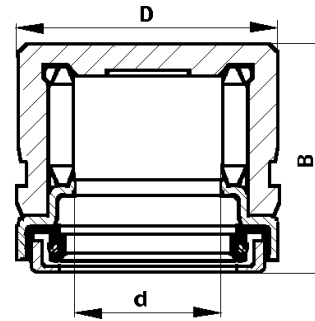

69-2201033-A

704702KV2

2201  
22038  
88  
88  
88  
88  
88  
88  
88  
88  
8

16,3

30

25

Роликовый радиальный игольчатый  
без внутреннего кольца  
Radial needle roller bearing without  
inner race

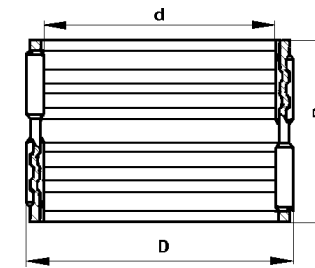

469-1701130

664908Д

1701

3

3

3

3

3

3

3

3

3

40

46

32

Роликовый игольчатый двухрядный  
без колец  
Double-row roller needle bearing  
without races

1	2	3	4	5	6	7	8	9	10	11	12	13	14	15
---	---	---	---	---	---	---	---	---	----	----	----	----	----	----

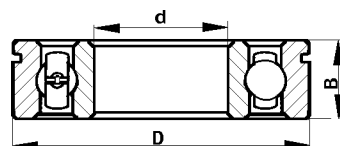

20-1701190

6-50306KV

1701  
1701+\*  
1802

1 1 1 1 1 1 1 1 1 1  
1 1 1 1 1 1 1 1 1 1  
3 3 3 3 3 3 3 3 3 3

30 72 19

Шариковый радиальный однорядный с канавкой для стопорной шайбы на наружном кольце  
Single-row radial ball bearing with groove for lock washer on outer race

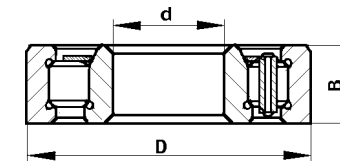

452-1802092

42305AE

1701

1 1 1 1 1 1 1 1 1 1

25 62 17

Роликовый радиальный однорядный с внутренним кольцом  
Single-row radial roller bearing with inner race

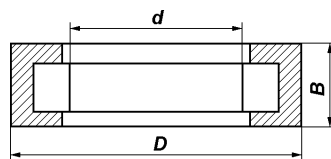

3741-1802092

6-292305-AE

1802

1 1 1 1 1 1 1 1 1 1

35 62 17

Роликовый радиальный однорядный без внутреннего кольца  
Single-row radial roller bearing without inner race

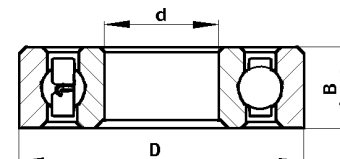

452-1701066

6-305  
6-305KШ1+  
305A+  
305KШ1+  
6-305AШ1+  
307A

1701+\*

1 1 1 1 1 1 1 1 1 1

25 62 17

Шариковый радиальный однорядный  
Single-row radial ball bearing

452-1802060

307A

1802

1 1 1 1 1 1 1 1 1 1

35 80 21

Шариковый радиальный однорядный  
Single-row radial ball bearing

3741-1802130

306  
6-306+  
306AK+

1802

1 1 1 1 1 1 1 1 1 1

30 72 19

Шариковый радиальный однорядный  
Single-row radial ball bearing



1	2	3	4	5	6	7	8	9	10	11	12	13	14	15
---	---	---	---	---	---	---	---	---	----	----	----	----	----	----

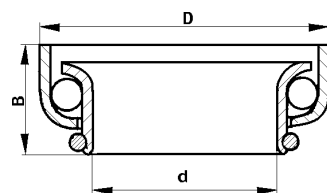

12-3401120	636905	3401	2	-	-	-	-	-	-	-	23,5	36,5	14
------------	--------	------	---	---	---	---	---	---	---	---	------	------	----

Шариковый радиально-упорный  
однорядный без сепаратора со  
штампованным кольцом  
Single-row radial-thrust ball bearing  
without cage, with stamped race

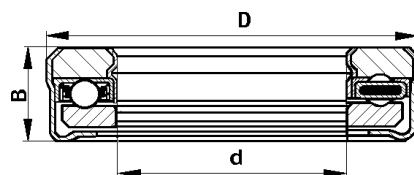

20-1601072	688911-C9 688911-C17+	1601	1	1	1	1	1	1	1	1	52,388	84,5	20,7
------------	--------------------------	------	---	---	---	---	---	---	---	---	--------	------	------

Шариковый упорный однорядный  
в защитном кожухе  
Single-row thrust ball bearing in  
protective housing



3160-1601182	B-6-520110AKC30Ш+	1601	1	1	1	1	1	1	1	1	50	82	20
--------------	-------------------	------	---	---	---	---	---	---	---	---	----	----	----

Шариковый упорный однорядный  
в защитном кожухе  
Single-row thrust ball bearing in  
protective housing

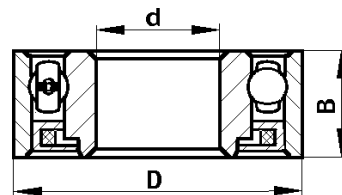

	60203-A 60203-K+	1005	1	1	1	1	1	1	1	1	17	40	12
--	---------------------	------	---	---	---	---	---	---	---	---	----	----	----

Шариковый радиальный однорядный  
с защитной шайбой  
Single-row radial ball bearing with  
protective washer

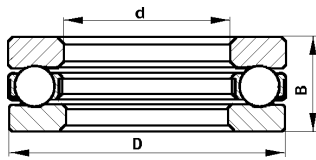
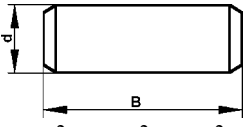
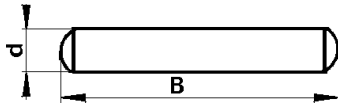
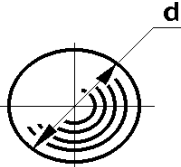
1	2	3	4	5	6	7	8	9	10	11	12	13	14	15		
																
	6-8102	3706	1	1	1	1	1	1	1	1	15	28	9	Шариковый радиально-упорный Radial-thrust ball bearing		
																
	11-7583	1601	3	3	3	3	3	3	3	3	5,5	-	9	Ролик 5,5x9 Roller 5.5x9		
																
	11-7569	1601	57	57	57	57	57	57	57	57	1,6	-	9	Ролик игольчатого подшипника Needle bearing roller		
																
	Б111 2,381 НЮ	1107	1	1	1	1	1	1	1	1	2,381	-	-	Шарик III Ball III		
	Б111 3,175 НЮ	1107	1	1	1	1	1	1	1	1	3,175	-	-	Шарик III Ball III		
	263003	2304	2	2	2	2	2	2	2	2	26,988			Шарик IV Ball IV		
	508626-A	2304	8	8	8	8	8	8	8	8	25,32-25,34	-	-	Шарик Б 25,4 Ball Б 25.4		
	367637	3515	1	1	1	1	1	1	1	1				Шарик IV Ball IV		
	353087	3507	2	2	2	2	2	2	2	2	11,9			Шарик I Ball I		
	508605-П	1701	6	6	6	6	6	6	6	6	6,35			Шарик БV Ball БV		
	263014	1702	3	3	3	3	3	3	3	3	9,525			Шарик VI Ball VI		
		1702+	3	3	3	3	3	3	3	3				Шарик VI Ball VI		
		1703	1	1	1	1	1	1	1	1						
		1803	3	3	3	3	3	3	3	3						